

ELECTRICAL OPTIONS/ SPECIFICATIONS

OUTPUT SUPPLY
 0.5 TO 4.5V RATIO METRIC 5V
 SUPPLY CURRENT 12mA TYP. 20mA MAX.

CABLE: 0.2mm², O/A SCREEN, PUR JACKET – SUPPLIED WITH 50cm OR REQUIRED LENGTH IN cm (15000cm MAX).
 STANDARD 3-CORE: JACKET Ø4mm BLACK e.g. 'L50'
 OPTIONAL 5-CORE: JACKET Ø4.6mm BLUE e.g. 'LQ50'

CABLE/CONNECTOR* CONNECTIONS;

3 CORE	5 CORE	CONNECTOR	
RED	RED	:1	+Ve
-	ORG	:1	+SENSE (5-WIRE ONLY)
BLACK	BLACK	:3	0V
-	GRY	:3	-SENSE (5-WIRE ONLY)
WHITE	WHITE	:2	OUTPUT
SCREEN	SCREEN	:4	BODY

*CONNECTORS; MAXIMUM CONDUCTOR CROSS SECTION 0.25mm²
 RANGE OF DISPLACEMENT FROM 0–15° TO 0–160° e.g. 76°, IN INCREMENTS OF 1°.

BODY MATERIAL:- STAINLESS STEEL.
 FLANGE BASE MATERIAL:- STAINLESS STEEL.
 SERVO MOUNT MATERIAL:- STAINLESS STEEL.

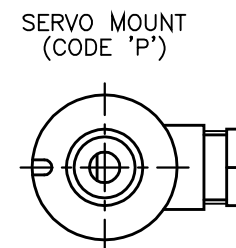
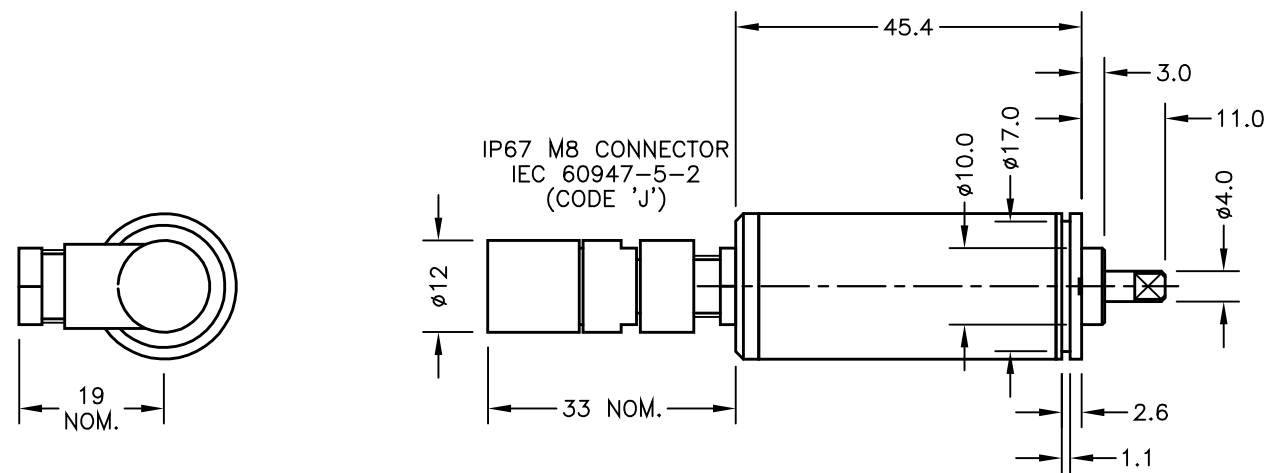
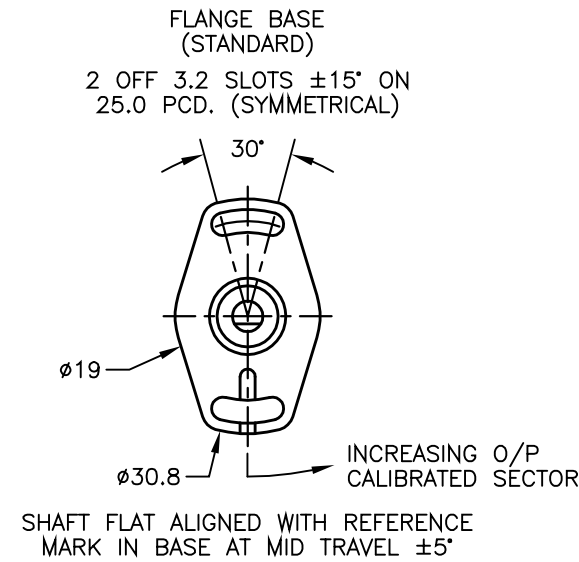
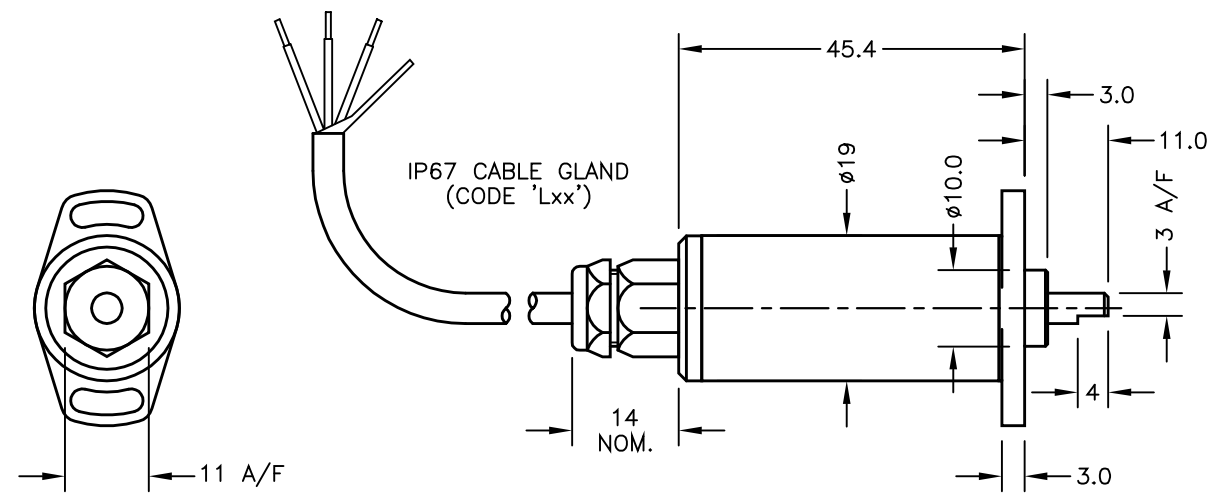

NOTE:- READ INSTALLATION SHEET E505-19 FOR FULL INSTRUCTIONS FOR USE.

ATEX / IECEx APPROVED TO
 II 1GD
 Ex ia IIC T4 Ga (Ta= -40° to +80°C)
 Ex ia IIIC T135°C Da (Ta= -40° to +80°C)
 Ui 11.4V, Ii 0.2A, Pi 0.51W

APPROVED FOR USE IN CONJUNCTION WITH A GALVANICALLY ISOLATED BARRIER.

NOTE: APPROVAL ONLY APPLIES AT NORMAL ATMOSPHERIC PRESSURE!



A	FIRST ISSUE	RDS
B	RANGE WAS 20° TO 160° RAN 442	RDS
C	APPROVAL STANDARDS UPDATED - RAN465.	PDM
D	SHAFT LENGTH REDUCED 0.5 - RAN538.	PDM
E	OPTION 'J' ADDED - RAN1068.	PDM
F	5-CORE OPTION ADDED ~ RAN1102	PDM
G	RANGE NOTE AMENDED ~ RAN1200	PDM



DRAWINGS NOT TO BE CHANGED WITHOUT REFERENCE TO THE CHANGE PROCEDURE.
 CHANGES TO PARTS USED IN INTRINSICALLY SAFE PRODUCT MUST BE APPROVED BY THE AUTHORISED PERSON
 THIS IS AN UNCONTROLLED PRINT AND WILL NOT BE UPDATED.

POSITEK

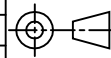
LIMITED

A	31/01/12	 CHECKED BY X RDS	X ±0.4
B	20/11/13		X.X ±0.2
C	12/03/14		X.XX ±0.1
D	21/01/15	DESCRIPTION	
E	02/12/15	E505 INTRINSICALLY SAFE	
F	27/04/17	SLIM-LINE ROTARY SENSOR	
G	12/09/17		
SCALE 5mm		DRAWING NUMBER	E505-11 REV G
		SHEET 1 OF 1	



E505 SLIM-LINE ROTARY SENSOR

INTRINSICALLY SAFE FOR HAZARDOUS DUST ATMOSPHERES

- **Intrinsically safe for Gas and Dust to: Ex II 1GD**
- **Non-contacting inductive technology to eliminate wear**
- **Angle set to customer's requirement**
- **Compact, durable and reliable**
- **High accuracy and stability**
- **Sealing to IP67**



As a leading designer and manufacturer of linear, rotary, tilt and intrinsically safe position sensors, Positek® has the expertise to supply a sensor to suit a wide variety of applications.

E505 incorporates electronics system EX07 which is ATEX / IECEx / UKEX approved for use in potentially explosive **gas/vapour and dust** atmospheres.

The E505 is an affordable, durable, high-accuracy rotary sensor designed for industrial and scientific feedback applications, but requires a smaller footprint than the E500. Like all Positek® sensors, the E505 provides a linear output proportional with input shaft rotation, which has full 360 degree rotational freedom.

Each unit is supplied with the output calibrated to the angle required by the customer, between 15 and 160 degrees and with full EMC protection built in.

It is particularly suitable for OEMs seeking good sensor performance for applications where space is important. Overall performance, repeatability and stability are outstanding over a wide temperature range.

The E505 has long service life and environmental resistance with stainless steel body parts. The flange or servo mounting options make the sensor easy to install. The E505 also offers a range of mechanical and electrical options. Environmental sealing is to IP67.

SPECIFICATION

Dimensions

Body diameter	19 mm
Body Length (to mounting face)	45.4 mm
Shaft	8 mm Ø 4 mm

For full mechanical details see drawing E505-11

Independent Linearity

$\leq \pm 0.25\%$ FSO @ 20°C - up to 100°

Temperature Coefficients

$< \pm 0.01\%/^{\circ}\text{C}$ Gain &
 $< \pm 0.01\%$ FS/ $^{\circ}\text{C}$ Offset

Frequency Response

> 10 kHz (-3dB)

Resolution

Infinite

Noise

$< 0.02\%$ FSO

Torque

< 15 mNm Static

Intrinsic Safety

Ex II 1GD

Ex ia IIC T4 Ga (Ta= -40°C to 80°C)

Ex ia IIIC T135°C Da (Ta= -40°C to 80°C)

Approval only applies to the specified ambient temperature range and atmospheric conditions in the range 0.80 to 1.10 Bar, oxygen $\leq 21\%$

Sensor Input Parameters

Ui: 11.4V, Ii: 0.20A, Pi: 0.51W.

(connector option/s)

Ci: 1.16 μ F, Li: 50 μ H

(cable option/s)

Ci: 1.36 μ F, Li: 860 μ H with 1km max. cable

Environmental Temperature Limits

Operating

-40°C to +80°C

Storage

-40°C to +125°C

Sealing

IP67

EMC Performance

EN 61000-6-2, EN 61000-6-3

Vibration

IEC 68-2-6: 10 g

Shock

IEC 68-2-29: 40 g

MTBF

350,000 hrs 40°C Gf

Drawing List

E505-11

Sensor Outline

3D models, step or .igs format, available on request.

Do you need a position sensor made to order to suit a particular installation requirement or specification? We'll be happy to modify any of our designs to suit your needs - please contact us with your requirements.

For further information please contact:

www.positek.com sales@positek.com

Tel: +44(0)1242 820027 fax: +44(0)1242 820615

Positek, Andoversford Industrial Estate, Cheltenham GL54 4LB. U.K.





E505 SLIM-LINE ROTARY SENSOR

INTRINSICALLY SAFE FOR HAZARDOUS DUST ATMOSPHERES

Intrinsically safe equipment is defined as "equipment which is incapable of releasing sufficient electrical or thermal energy under normal or abnormal conditions to cause ignition of a specific hazardous atmosphere mixture in its most easily ignited concentration."

ATEX / IECEx / UKEX approved to;

- Ex II 1GD
- Ex ia IIC T4 Ga (Ta= -40°C to 80°C)
- Ex ia IIIC T135°C Da (Ta= -40°C to 80°C)

Designates the sensor as belonging to; Group II: suitable for all areas **except mining**, Category 1 GD: can be used in areas with continuous, long or frequent periods of exposure to hazardous gas / vapour (Zones 2 to 0) and dust (Zone 20).

Gas / Vapour:

Protection class ia, denotes intrinsically safe for all zones

Apparatus group IIC: suitable for IIA, IIB and IIC explosive group / vapour.

Temperature class T4: maximum sensor surface temperature under fault conditions 135°C.

Dust:

T135°C: maximum sensor surface temperature under fault conditions.

Ambient temperature range extended to -40°C to +80°C.

It is imperative Positek® intrinsically safe sensors be used in conjunction with a galvanic barrier to meet the requirements of the product certification. The Positek X005 Galvanic Isolation Amplifier is purpose made for Positek IS sensors making it the perfect choice. Refer to the X005 datasheet for product specification and output configuration options.

For cable lengths exceeding 10 metres a five wire connection is recommended to eliminate errors introduced by cable resistance and associated temperature coefficients.

ATEX / IECEx / UKEX approved sensors suitable for gas (X series) and mining (M series) applications, are also available from Positek.

E505	a	b	c	d	e
	Displacement	A	Connections	Option	Z000

a Displacement	Value
Factory set to any angle from 0-16° (±8°) to 0-160° (±80°) (e.g. 0-54°)	54
b Output	
Supply V_{dc} (tolerance)	Output
+5V (4.5 - 5.5V)	0.5 - 4.5V (ratiometric with supply)
Supply Current 10mA typical, 12mA max.	
c Connections	Code
Connector axial IP67 4 pin M8 IEC 61076-2-104, metal	J
Connector axial IP67 4 pin M8 IEC 61076-2-104, metal, pre-wired 3-core cable	Jxx
Cable gland axial IP67 M8, metal, 3-core cable	Lxx
Cable gland axial IP67 M8, metal, 5-core cable	LQxx
Specify required cable length 'xx' in cm. e.g. L2000 specifies axial cable gland with 20 m of cable, 50 cm supplied as standard. Note! maximum length supplied 15000cm. N.B.! M8 connector option with 5-core cable not available.	
d Sensor Mounting	Code
Flange default	blank
Servo Mount	P
See drawing E505-11 for details.	

e Z-code	Code
Calibration to suit X005 required	Z000

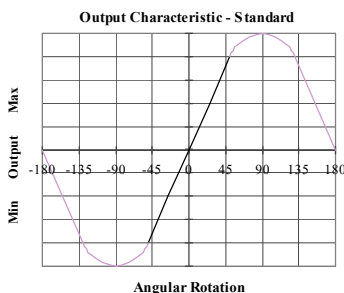

For further information please contact:

www.positek.com sales@positek.com

Tel: +44(0)1242 820027 fax: +44(0)1242 820615

Positek, Andoversford Industrial Estate, Cheltenham GL54 4LB. U.K.



Three or Five-Wire Mode Connection

FOR INTRINSICALLY SAFE SENSORS IN HAZARDOUS ATMOSPHERES

The aim of this document is to help readers who do not understand what is meant by three or five wire modes of connection between the galvanic isolation amplifier and sensor, and the factors behind them. It is by no means an in-depth technical analysis of the subject.

Whether opting for a pre-wired Positek® Intrinsicly Safe sensor or one with a connector, choosing the right mode of connection and cable to suit the application requires careful consideration.

Interconnecting cables are not perfect conductors and offer resistance to current flow, the magnitude of resistance[†] depends on conductors resistivity, which changes with temperature, cross sectional area[‡] and length. If the voltage were to be measured at both ends of a length of wire it would be found they are different, this is known as volts drop. Volts drop changes with current flow and can be calculated using Ohm's law, it should be noted that volts drop occurs in both positive and negative conductors. The effects of volts drop can be reduced by increasing the conductors cross sectional area, this does not however eliminate the effects due to temperature variation. There are instances where large cross-section cables are not practical; for example most standard industrial connectors of the type used for sensors have a maximum conductor capacity of 0.75mm², copper prices and ease of installation are other considerations.

This is important because the effects of volts drop can significantly alter the perceived accuracy of the sensor which is ratiometric i.e. the output signal is directly affected by the voltage across the sensor. Changes in temperature will also be seen as gain variation in the sensor output.

Three wire mode connections are common and are suitable in most cases with short or moderate cable runs. Applications that do not require a high degree of accuracy but have cable runs, say in excess of 10m, volts drop can be reduced by introducing a terminal box close to the sensor and using a larger cross-section cable for a majority of the cable run. Sensors supplied with three core cable are calibrated with the cable fitted which largely eliminates errors due to conductor resistance at room temperature however, as mentioned above, small gain errors due to temperature fluctuations should be expected.

Five wire mode connections have significant benefits as losses in the positive and negative conductors are compensated for by the galvanic isolation amplifier which can 'sense' the voltage across the sensor and dynamically adjust the output voltage so that the voltage across the sensor is correct. The effects of cable resistance and associated temperature coefficients are eliminated allowing for smaller conductors than a three wire connection for the same cable run. The amplifier can compensate for up to 15Ω per conductor with a current flow of 15mA, which is more than adequate for 150m of 0.25 mm² cable, longer lengths will require larger conductors.

For this reason Positek® recommends five wire connections for cable lengths exceeding 10 metres in 0.25 mm² cable to preserve the full accuracy of the sensor.

See illustrations below for examples of connecting a sensor to the galvanic isolation amplifier.

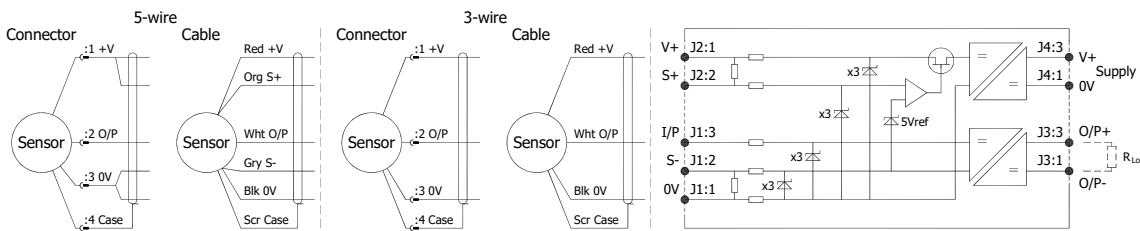

Cable Length (metres)	Up to 150	150 - 300	300 - 450	450 - 600	600 - 900	900 - 1000
Cross Section (mm ²)	0.25	0.5	0.75	1.0	1.5	2.0

The table above shows recommended conductor sizes with respect to cable length for both three and five wire connections, based on copper conductors. Three wire connections will introduce a gain reduction of 5% and a ±1% temperature dependence of gain over the range -40°C to +80°C for the cable temperature. (i.e. about -150 ppm/°C for the maximum lengths shown and less pro rata for shorter lengths.)

It should be noted that the maximum cable length, as specified in the sensor certification, takes **precedence** and **must not** be exceeded.

Positek® sensors are supplied with three core 0.25 mm² cable as standard, however five core 0.25 mm² cable can be supplied on request. The galvanic isolation amplifier is available as;

- G005-*** for 'G' and 'H' prefix sensors
- X005-*** for 'E', 'M' and 'X' prefix sensors

[†] $R = \rho L/A$ ρ is the resistivity of the conductor (Ωm) L is the length of conductor (m) A is the conductor cross-sectional area (m²).

[‡] It is presumed that direct current flow is uniform across the cross-section of the wire, the galvanic isolation amplifier and sensor are a dc system.



For further information please contact:

www.positek.com sales@positek.com

Tel: +44(0)1242 820027 fax: +44(0)1242 820615

Positek, Andoversford Industrial Estate, Cheltenham GL54 4LB. U.K.



Installation Information

E505 SLIM LINE ROTARY SENSOR

INTRINSICALLY SAFE FOR HAZARDOUS DUST ATMOSPHERES

For certificate number and safety parameters information for product marked EX04, see next page.

ATEX / IECEx / UKEX Qualified to Intrinsic Safety Standard Certificate numbers SIRA 13ATEX2371X IECEX SIR 13.0154X CSAE 21UKEX2573X		Ex II 1GD Ex ia IIC T4 Ga (Ta = -40°C to +80°C) Ex ia IIIC T135°C Da (Ta = -40°C to +80°C)	
Electronics Version	Output Description:	Supply Voltage: Vs (tolerance)	Load resistance:
EX07	0.5 - 4.5V (ratiometric with supply) [Output code 'A']	+5V (4.5 - 5.5V)	5kΩ min

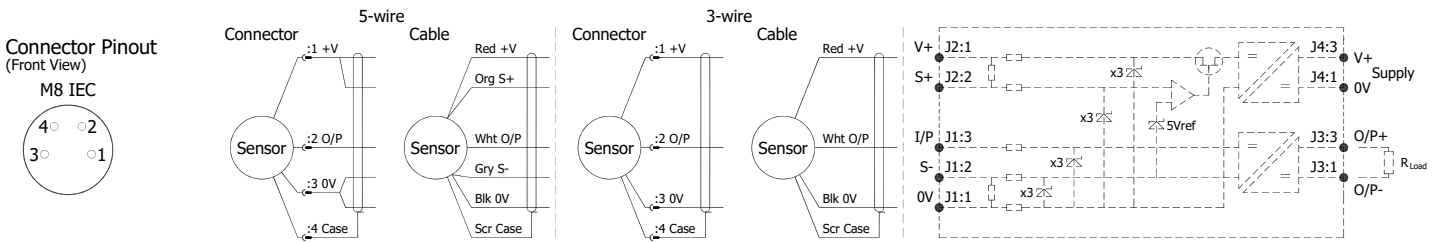

Putting Into Service: The sensor must be used with a galvanic isolation barrier designed to supply the sensor with a nominal 5V and to transmit the sensor output to a safe area. The barrier parameters must not exceed:-

- Ui = 11.4V**
- Ii = 0.20A**
- Pi = 0.51W**
- Ci = 1.36µF***
- Li = 860µH*** (with maximum cable length)
- Ci = 1.16µF**
- Li = 50µH** (without cable)

*Figures for 1km cable where: Ci = 200pF/m & Li = 810nH/m

The sensor is certified to be used with up to **1000m** of cable, cable characteristics must not exceed:-

- Capacitance: ≤ 200 pF/m for max. total of: 200 nF
- Inductance: ≤ 810 nH/m for max. total of: 810 µH

Approval only applies to specified ambient temperature range and atmospheric conditions in the range: 0.80 to 1.10 Bar, oxygen ≤ 21%.

The performance of the sensor may be affected by voltage drops associated with long cable lengths; For cable lengths exceeding 10 metres a five wire connection is recommended to eliminate errors introduced by cable resistance and associated temperature coefficients.

Special Condition for Safe Use:

The apparatus does not meet the 500 V r.m.s dielectric strength test between circuit and frame, in accordance with clause 6.3.13 of IEC 60079-11:2011. This must be taken into consideration on installation.

When using a Sensor that has an integral cable in a dust application, the free end of the cable shall be appropriately terminated for the zone of use.

Under certain extreme circumstances, the non-metallic and isolated metal parts incorporated in the enclosure of this equipment may generate an ignition-capable level of electrostatic charge. Therefore the equipment shall not be installed in a location where the external conditions are conducive to the build-up of electrostatic charge on such surfaces. This is particularly important if the equipment is installed in a zone 0 location. In addition, the equipment shall only be cleaned with a damp cloth.

Use: The sensor is designed to measure rotary displacement and provide an analogue output signal.

Assembly and Dismantling: The unit is not to be serviced or dismantled and re-assembled by the user.

Maintenance: No maintenance is required.

Mechanical Mounting: Flange mounted - see drawing E505-11. The sensor should be mounted with minimal axial and radial loading on the shaft for optimum life. It is recommended that the shaft is coupled to the drive using a flexible coupling, recommended maximum axial load 1kg. Tests indicate that life in excess of 16 million cycles can be achieved with 1kg side and end load.

Output Characteristic: The sensor has full rotational freedom and two sectors, 180° apart, over which linear response can be achieved. At the mid point of the calibrated range the output signal will be half full scale deflection, and the flat on the shaft is aligned with the registration mark in the base of the sensor. In the calibrated range the output increases as the shaft is rotated in an anti-clockwise direction viewed from the shaft. The calibrated output is factory set to be between 15° and 160°.

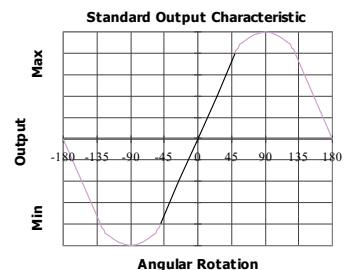

Incorrect Connection Protection levels: Not protected – the sensor is **not** protected against either reverse polarity or over-voltage. The risk of damage should be minimal where the supply current is limited to less than 50mA.



For further information please contact:

www.positek.com sales@positek.com

Tel: +44(0)1242 820027 fax: +44(0)1242 820615

Positek, Andoversford Industrial Estate, Cheltenham GL54 4LB. U.K.



Installation Information

E505 SLIM LINE ROTARY SENSOR

INTRINSICALLY SAFE FOR HAZARDOUS DUST ATMOSPHERES

For certificate number and safety parameters information for product marked EX07, see previous page.

ATEX Qualified to Intrinsic Safety Standard Certificate numbers SIRA 00ATEX2076X		Ex II 1GD EEx ia I/IIC T4 (Ta = -40°C to +80°C) Ex ia D 20 T135°C (Ta = -40°C to +80°C)	
Electronics Version	Output Description:	Supply Voltage: V _s (tolerance)	Load resistance:
EX04	0.5 - 4.5V (ratiometric with supply) [Output code 'A']	+5V (4.5 - 5.5V)	5kΩ min

The barrier parameters must not exceed:-

U_i = 11.4V **I_i = 0.20A** **P_i = 0.51W**
C_i = 1.36μF* **L_i = 710μH*** *Figures for 1km cable
C_i = 1.16μF **L_i = 50μH** without cable

The sensor is certified to be used with up to **1000m** of cable, cable characteristics must not exceed:-

Capacitance: ≤ 200 pF/m for max. total of: 200 nF
Inductance: ≤ 660 nH/m for max. total of: 660 μH

With the exception of the certificate number and safety parameters above, all other notes regarding Putting Into Service, Use, Assembly and Dismantling etc. on previous page apply to sensors marked EX04 or EX07.



For further information please contact:
www.positek.com sales@positek.com
Tel: +44(0)1242 820027 fax: +44(0)1242 820615
Positek, Andoversford Industrial Estate, Cheltenham GL54 4LB. U.K.