

ROTAMAG

Magnetic absolute encoders

Series

MM58 • MM58S • MMC58



- Rugged & compact multi turn encoder
- Stainless steel housing
- Magnetic sensing
- Through hollow shaft version available
- Up to 32768 turns (65536 on request)

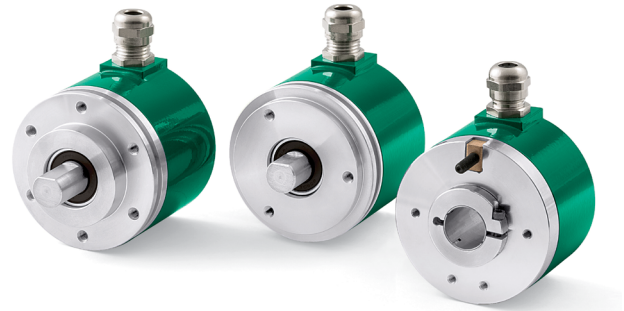

MM58S • MM58 • MMC58

ENVIRONMENTAL SPECIFICATIONS

Shock:	100 g, 6 ms
Vibrations:	10 g, 5-2000 Hz
Protection:	IP65
Operating temperature range:	-20°C +85°C (-4°F +185°F)
Storage temperature range:	-20°C +85°C (-4°F +185°F) (98% R.H. without condensation)
Option:	• protection IP67

MECHANICAL SPECIFICATIONS

Dimensions:	see drawing
Shaft diameter:	Ø 6, 8, 9.52, 10, 12 mm
Hollow shaft diameter:	Ø 14, 15 mm
Reducing sleeves BR1-xx from Ø 15 mm to:	Ø 6, 8, 9.52, 10, 11, 12 mm
Shaft loading (axial, radial):	100 N max.
Shaft rotational speed:	12000 rpm max.
Starting torque (at 20°C):	MM58: 0,15 Ncm (typical) MM58S: 0,40 Ncm (typical) MMCxx: 1 Ncm (typical)
Bearings life:	400 x10 ⁶ rev. min. (10 ⁹ rev. min. with 20 N shaft loading max.)
Electrical connections:	cable output 1 m (3.3 ft)
Weight:	~ 450 g (15,8 oz)
Option:	• additional cable

ELECTRICAL SPECIFICATIONS

Resolution:	1024 cpr x 32768 turns 2048 cpr x 16384 turns 4096 cpr x 8192 turns
Accuracy:	± 1°
Output circuits:	SSI (clock 500 kHz, T _p =64 µsec.)
Output code:	Gray, Binary
Counting frequency:	20 kHz max.
Start-up time:	200 msec.
Power supply:	+10Vdc +30Vdc
Output current:	20 mA max.
Protection:	against inversion of polarity, short-circuit
EMC:	electro-magnetic immunity, according to: EN-61000-4-2 EN-61000-4-4
Battery life:	10 years min.
Functions:	• Counting direction (input) • Electronic zero setting (input)

MATERIALS

Flange:	AISI 420, UNI EN 4021
Housing:	AISI 420, UNI EN 4021
Bearings:	ABEC 5
Shaft:	stainless steel, non magnetic, UNI EN 4305

PREFERENTIAL MODEL

MMC5812/8192GB-15-L1	SSI, 25 bit
----------------------	-------------

ACCESSORIES

PAN/PGF:	flexible couplings
BR1:	reducing sleeves
LKM-386:	fixing clamps

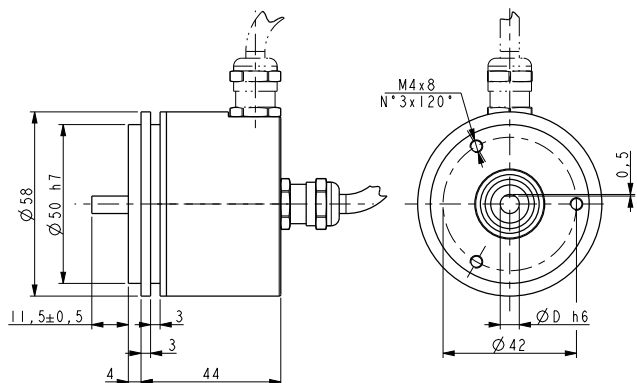

MM58

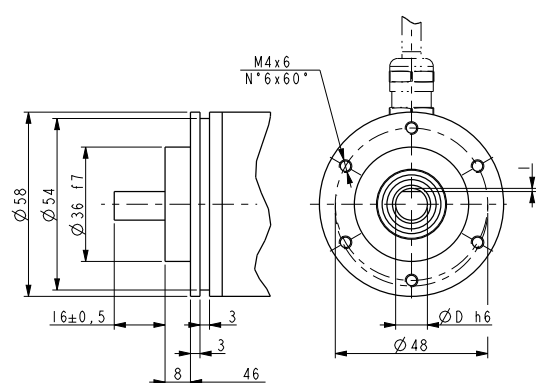

MM58S

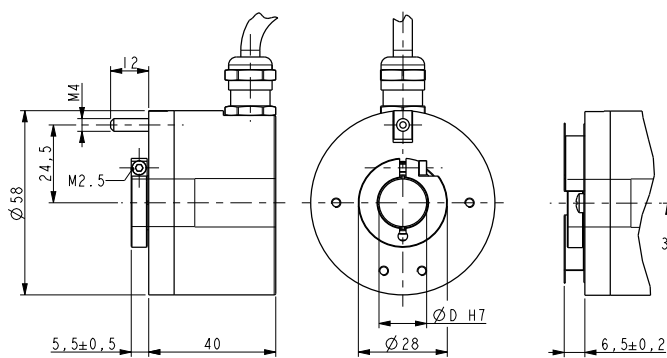

MMC58

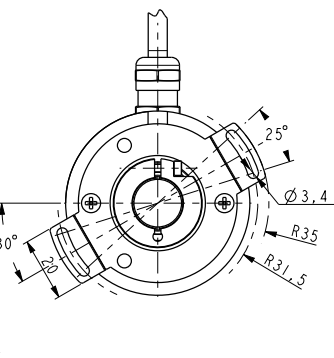

MMC59

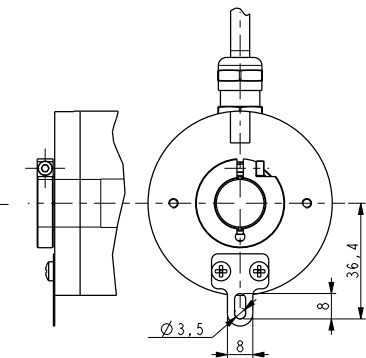

MMC60

Order code

MM58	XX/XXXXX	XX	-	XX	-	X	X	XX	/Sxxx
MM58S	Ⓐ	Ⓑ		Ⓒ		Ⓓ	Ⓔ	Ⓕ	Ⓖ
MMC58									
MMC59									
MMC60									

<p>Ⓐ RESOLUTION</p> <p>10/32768 = 1024 cpr x 32768 turns</p> <p>11/16384 = 2048 cpr x 16384 turns</p> <p>12/8192 = 4096 cpr x 8192 turns</p> <p>Ⓑ OUTPUT</p> <p>BB = Binary, SSI LSB aligned</p> <p>GB = Gray, SSI LSB aligned</p>	<p>Ⓒ SHAFT DIAMETER</p> <p>6 = 6 mm</p> <p>8 = 8 mm</p> <p>P9 = 9.52 mm, 3/8"</p> <p>10 = 10 mm</p> <p>12 = 12 mm</p> <p>14 = 14 mm (only for MMCxx)</p> <p>15 = 15 mm (only for MMCxx)</p>	<p>Ⓓ CONNECTOR POSITION</p> <p>- = axial (standard)</p> <p>R = radial (mandatory on MMCxx series)</p> <p>Ⓔ PROTECTION</p> <p>- = IP65 (standard)</p> <p>J = IP67 with sealed circuit</p>	<p>Ⓕ CABLE LENGTH</p> <p>L1 = cable output 1 m (standard)</p> <p>L2 = cable output 2 m</p> <p>Lx = cable output x m</p>
			<p>Ⓖ CUSTOM VERSION</p>